

STYLE

CIRCLE STYLE(S)

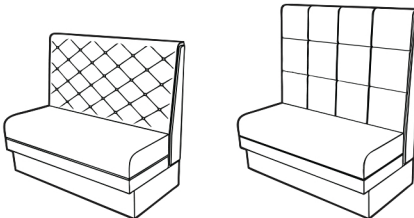

DRAWING+CALLOUTS

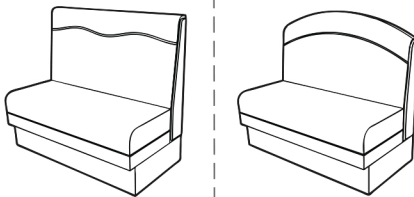
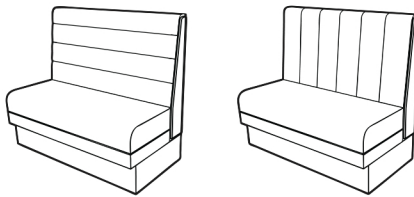
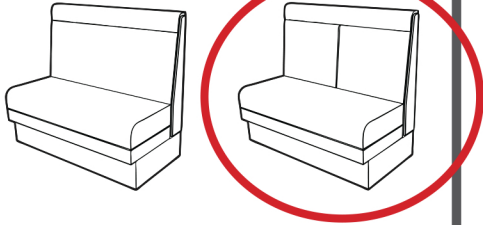
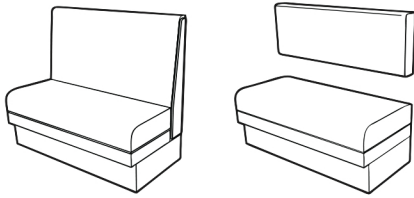
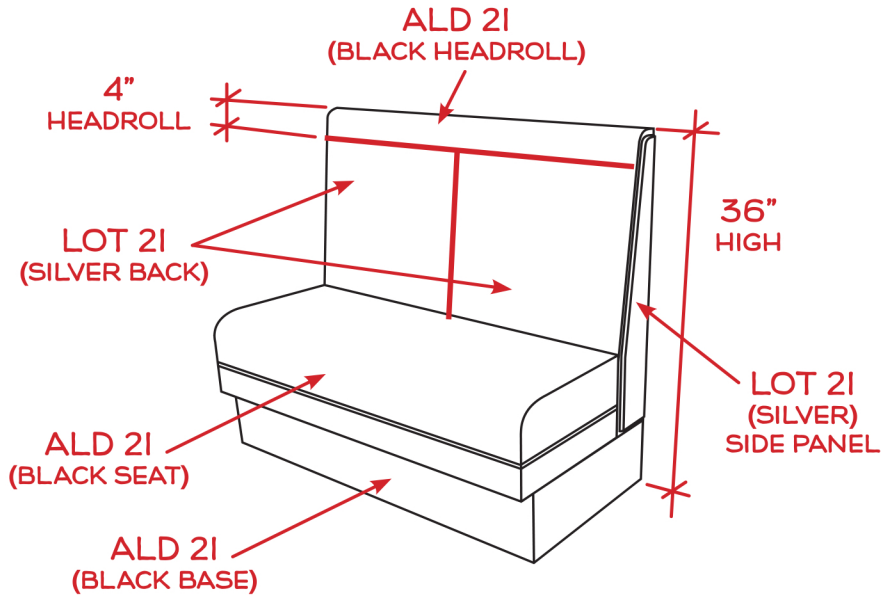

OPEN BACK



VINYL



PLYWOOD



OTHER

SEE NOTES

SINGLE QTY: 4+1



DOUBLE QTY: 2+1



BANQUETTE QTY: 1+1

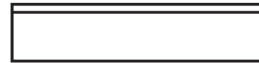

SEE NOTES

3/4 QTY:

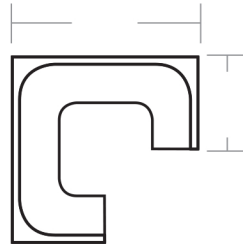

U-SHAPE QTY: 1

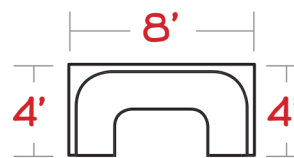

DETAILS

MARKED FOR: ABC RESTAURANT SUPPLY

ORDERED BY: PR - RYAN

NOTES: _____

QTY 4 - SINGLE BOOTHS, 48"
(W/ VINYL OVER PLY BACK COVER)

QTY 1 - SINGLE BOOTH, 72"
(W/ VINYL OVER PLY BACK COVER)

QTY 2 - DOUBLE BOOTHS, 72"

QTY 1 - DOUBLE BOOTH, 48"

QTY 1 - BANQUETTE BOOTH, 24'
(NO BACK COVER - AGAINST WALL)

QTY 1 - BANQUETTE BOOTH, 11'
(NO BACK COVER - AGAINST WALL)

QTY 1 - U-SHAPE BOOTH, 4' X 8' X 4'
(NO BACK COVER ON 8' SIDE - BOTH 4' SIDES HAVE VINYL OVER PLY)

TO/ATTN: KEITH

TEL: 602-861-2828

FAX: 602-216-8282

EMAIL: KEITH@NIULINE.COM