

PRODUCT 101 | BASES

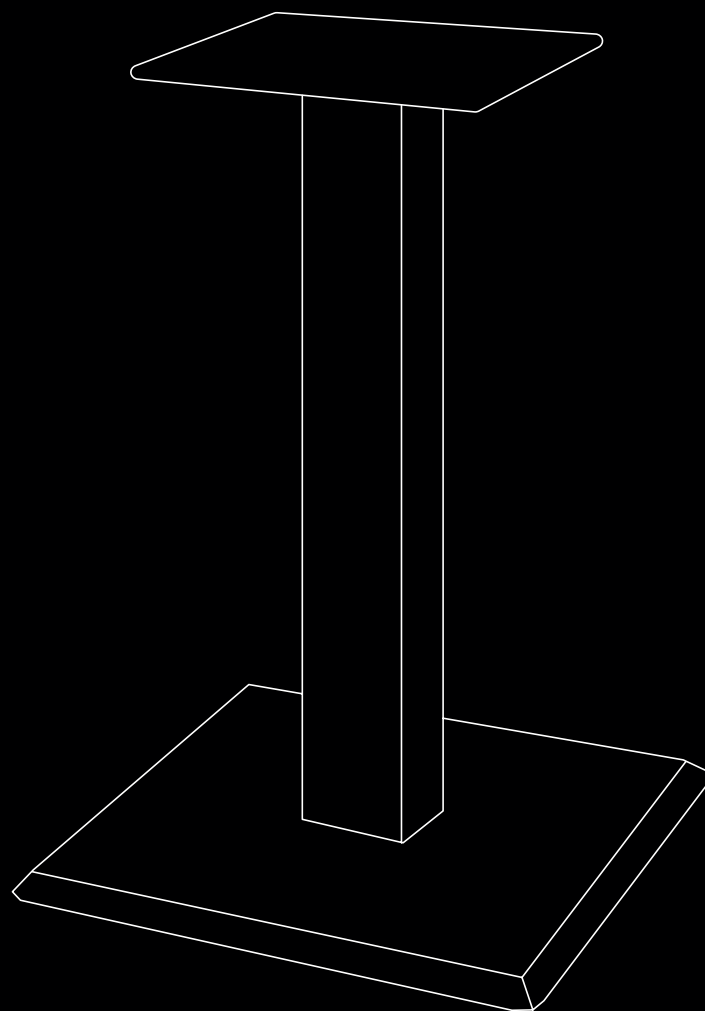

STANDARD HEIGHT BASE DIMENSIONS

UNIVERSAL MOUNTING PLATE

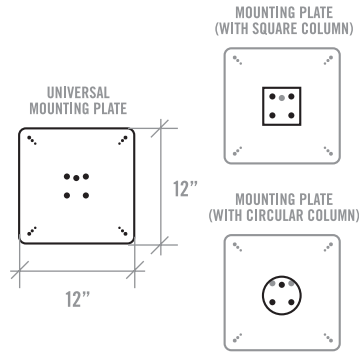

COLUMN TYPES

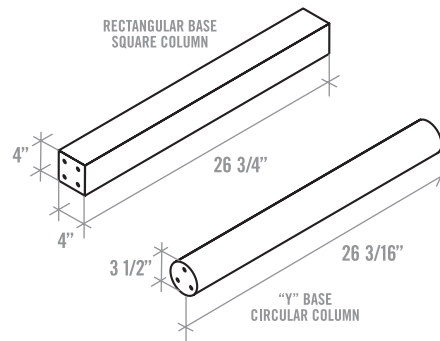

OVERALL HEIGHT

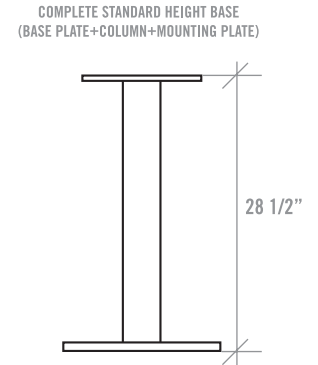

MTB1515SH-(FB OR CH)

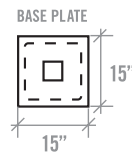

MTB1818SH-(FB OR CH)

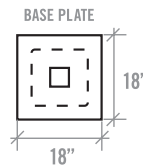

MTB2121SH-(FB OR CH)

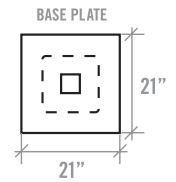

MTB1523SH-(FB OR CH)

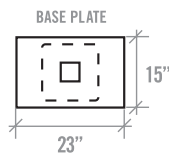

MTB22YSH-FB



MTB28YSH-FB



MTB35YSH-FB



MTB22ESH-FB

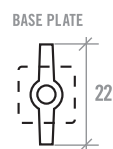

BAR HEIGHT BASE DIMENSIONS

UNIVERSAL MOUNTING PLATE

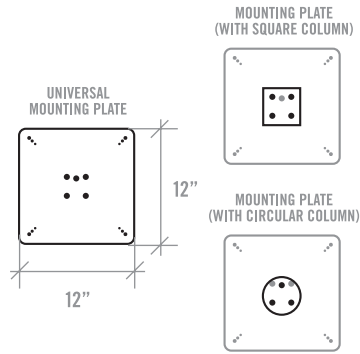

COLUMN TYPES

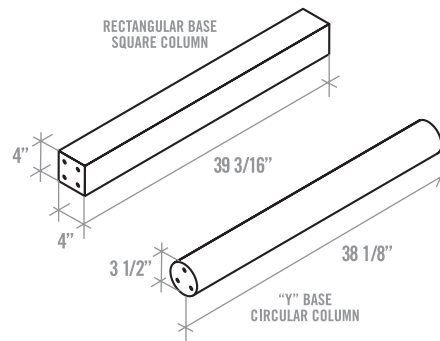

OVERALL HEIGHT

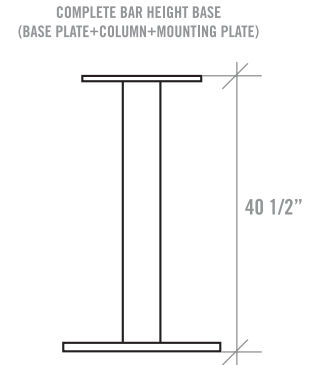

MTB1515BH-(FB OR CH)

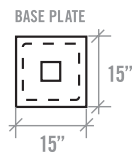

MTB1818BH-(FB OR CH)

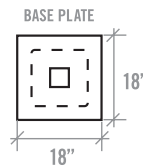

MTB2121BH-(FB OR CH)

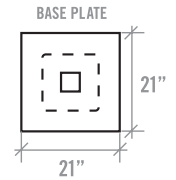

MTB1523BH-(FB OR CH)

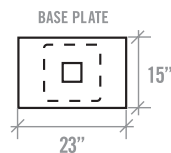

MTB28YBH-FB







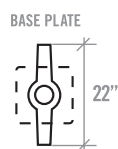

MTB35YBH-FB

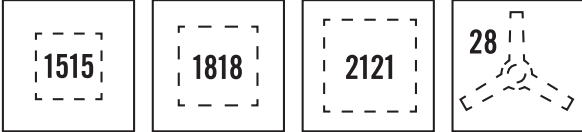

MTB22EBH-FB

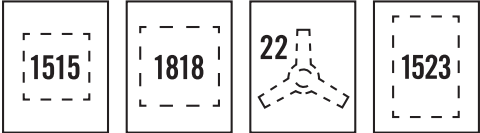

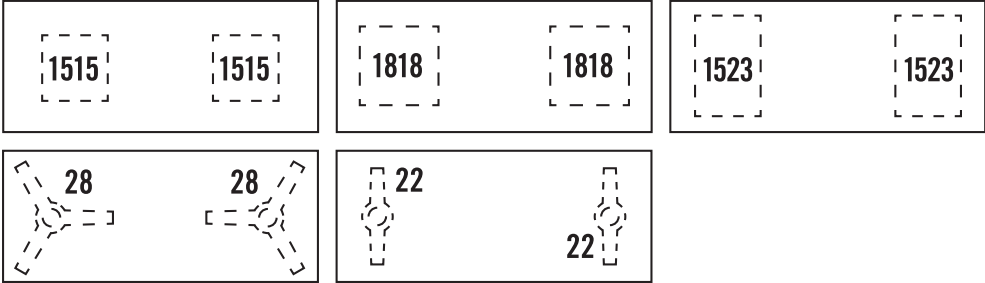

RECTANGULAR TOPS/STANDARD HEIGHT*

24" X 24"	
30" X 30"	
36" X 36"	
24" X 30"	
30" X 42"	
30" X 48"	
30" X 60"	
30" X 72"	

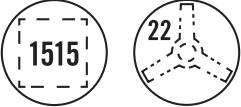
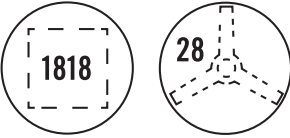

*PLEASE NOTE: THE ABOVE CORRECT USAGE DIAGRAMS ARE FOR NIULINE BASES WITH NIULINE MFB TABLE TOPS ONLY. PLEASE CONSULT NIULINE FOR ANY OTHER TABLE TOP SUBSTRATES (GRANITE, BUTCHER BLOCK, ETC.)

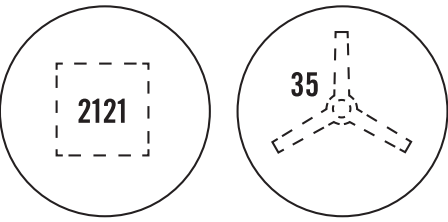
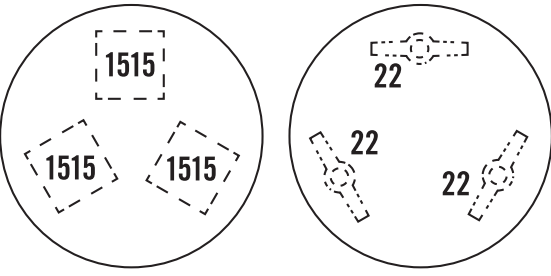
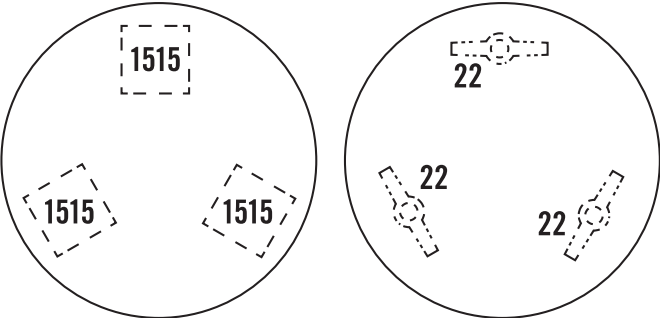
CIRCULAR TOPS/STANDARD HEIGHT*

24" ROUND	
30" ROUND	
36" ROUND	
48" ROUND	
60" ROUND	
72" ROUND	

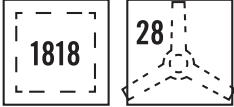
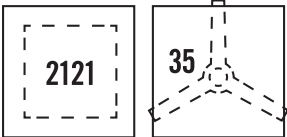

*PLEASE NOTE: THE ABOVE CORRECT USAGE DIAGRAMS ARE FOR NIULINE BASES WITH NIULINE MFB TABLE TOPS ONLY. PLEASE CONSULT NIULINE FOR ANY OTHER TABLE TOP SUBSTRATES (GRANITE, BUTCHER BLOCK, ETC.)

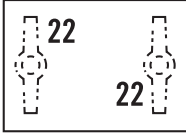
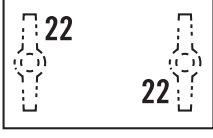
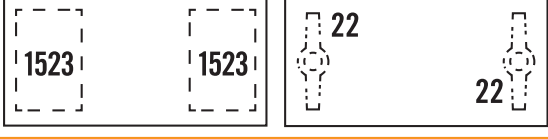
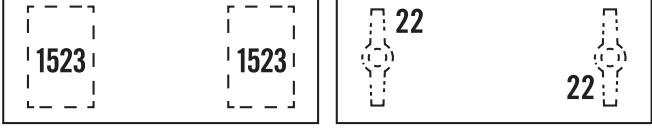
RECTANGULAR TOPS/BAR HEIGHT*

24" X 24"	
30" X 30"	
36" X 36"	
24" X 30"	
30" X 42"	
30" X 48"	
30" X 60"	
30" X 72"	

*PLEASE NOTE: THE ABOVE CORRECT USAGE DIAGRAMS ARE FOR NIULINE BASES WITH NIULINE MFB TABLE TOPS ONLY. PLEASE CONSULT NIULINE FOR ANY OTHER TABLE TOP SUBSTRATES (GRANITE, BUTCHER BLOCK, ETC.)

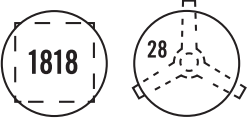
CIRCULAR TOPS/BAR HEIGHT*

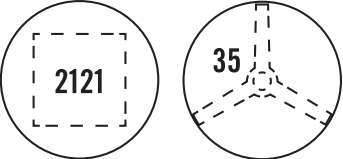
24" ROUND	
30" ROUND	
36" ROUND	

*PLEASE NOTE: THE ABOVE CORRECT USAGE DIAGRAMS ARE FOR NIULINE BASES WITH NIULINE MFB TABLE TOPS ONLY. PLEASE CONSULT NIULINE FOR ANY OTHER TABLE TOP SUBSTRATES (GRANITE, BUTCHER BLOCK, ETC.)